

Annex A

Section VI. Schedule of Requirements

The delivery schedule expressed as weeks/months stipulates hereafter a delivery date which is the date of delivery to the project site.

Item Number	Description	Quantity	Total	Delivered, Weeks/Months
1	Bookshelves (ducco finish) w/seating (leather 3 inches cushion) Note: Please refer to Fig. 1.1 – Fig. 1.1c	4 units		30 CD
2	Bookshelves one-sided Note: Please refer to Figure 1.2	16 units	16 units	30 CD
3	Bookshelves double-sided – high Bookshelves double-sided – low Note: Please refer to Figure 1.3	27 units 7 units	34 units	30 CD
4	Bookshelves one-sided (column) Note: Please refer to Figure 1.4	2 units	2 units	30 CD
5	Platform seating w/3 in cushion seat – Fig. 1.5	1 unit	1 unit	30 CD
	Built-in Magazine Rack – 4 layers	1 unit	1 unit	30 CD
	Built-in Magazine Rack on columns	3 units	3 units	30 CD
	Built-in Periodicals Rack – 4 layers	1 unit	1 unit	30 CD

Section VII. Technical Specifications

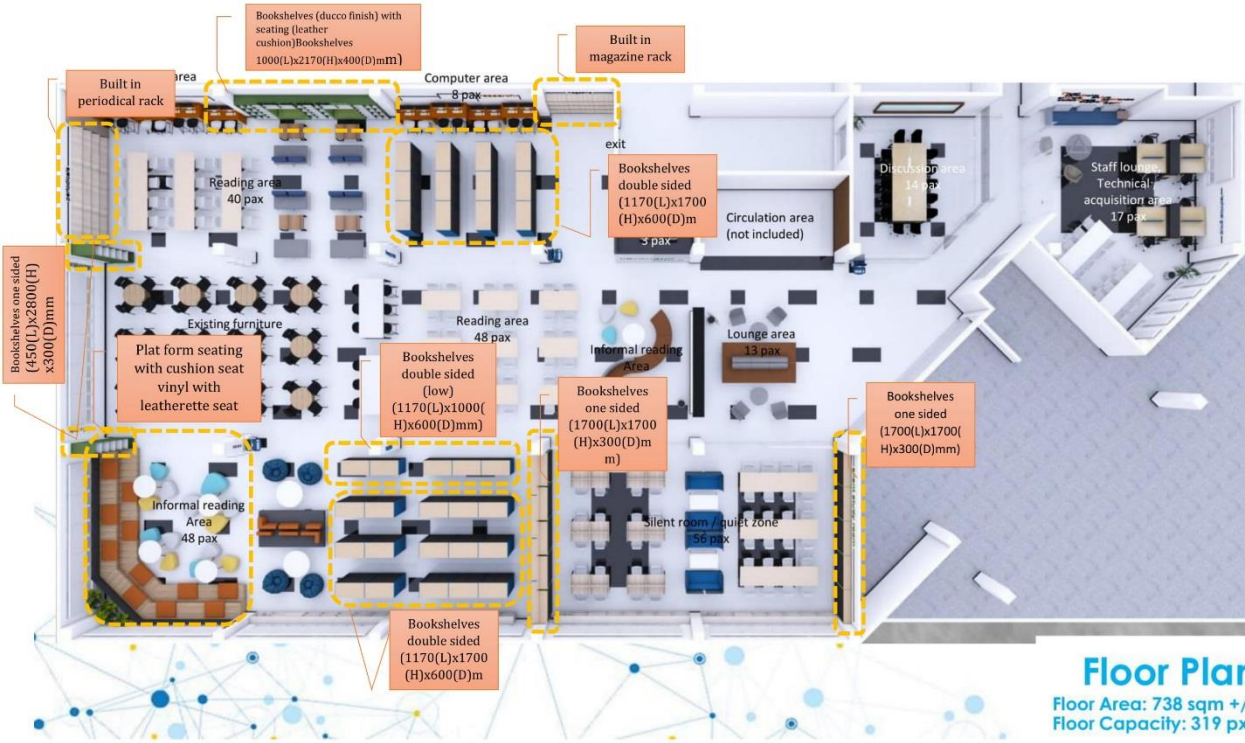

Floor Plan

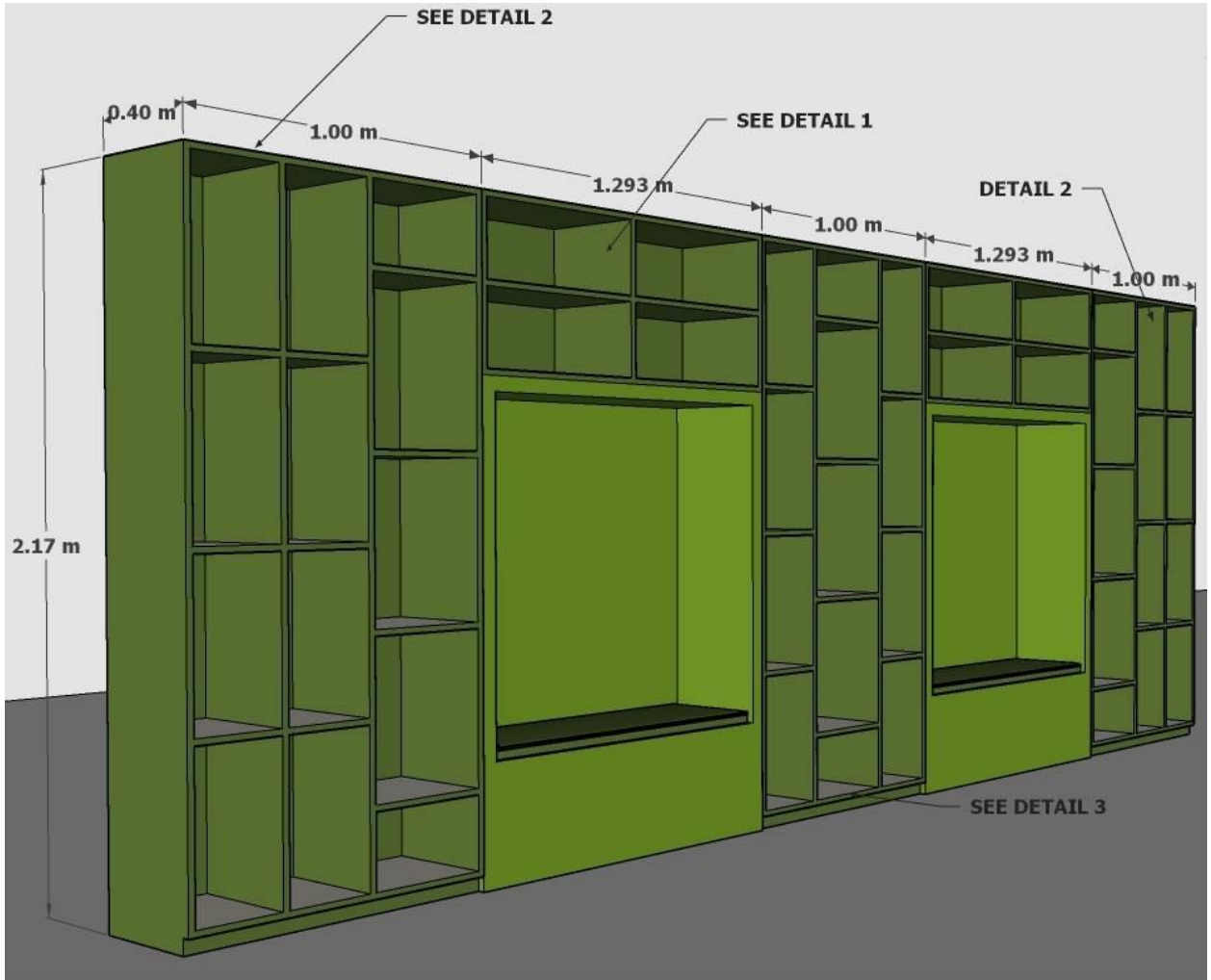

Figure 1.1

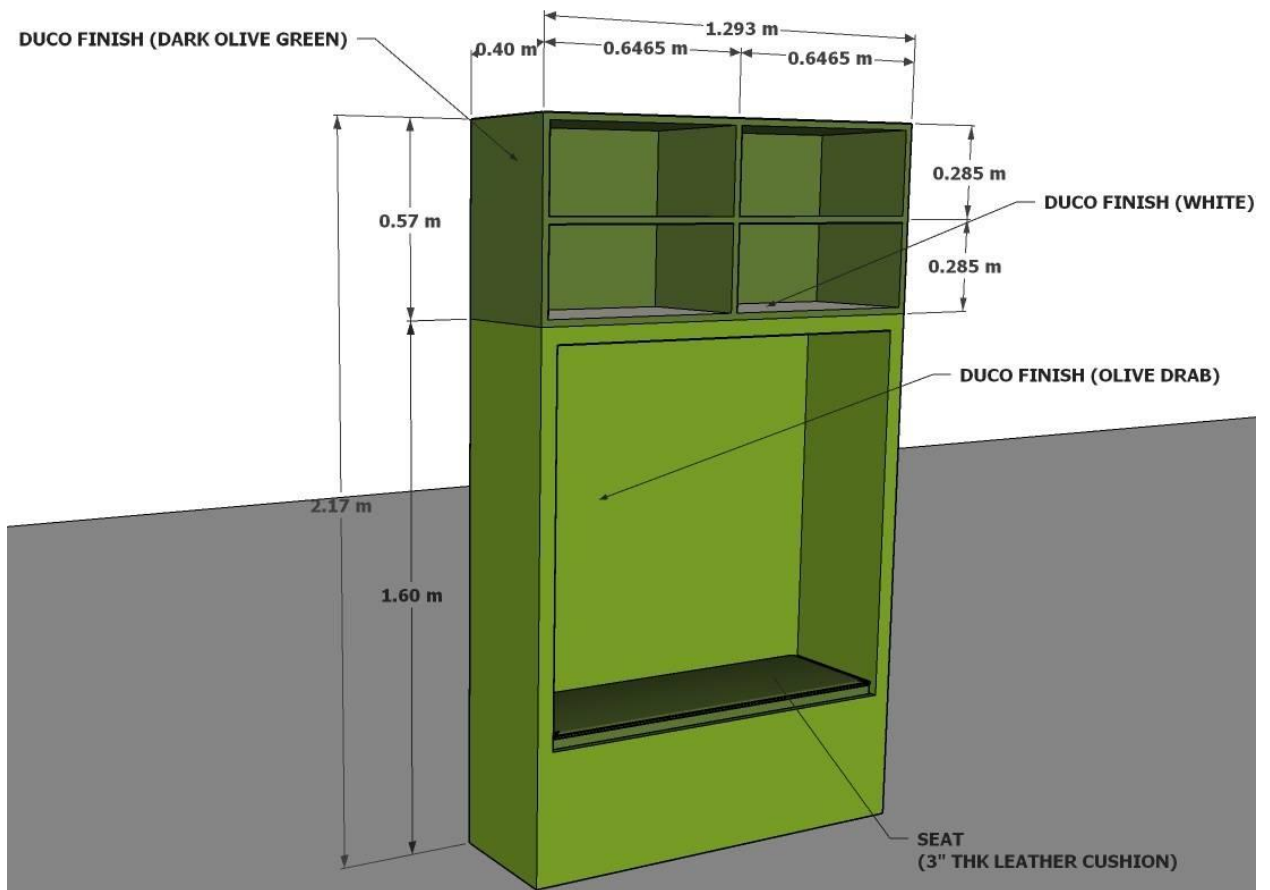

Figure 1.1.a

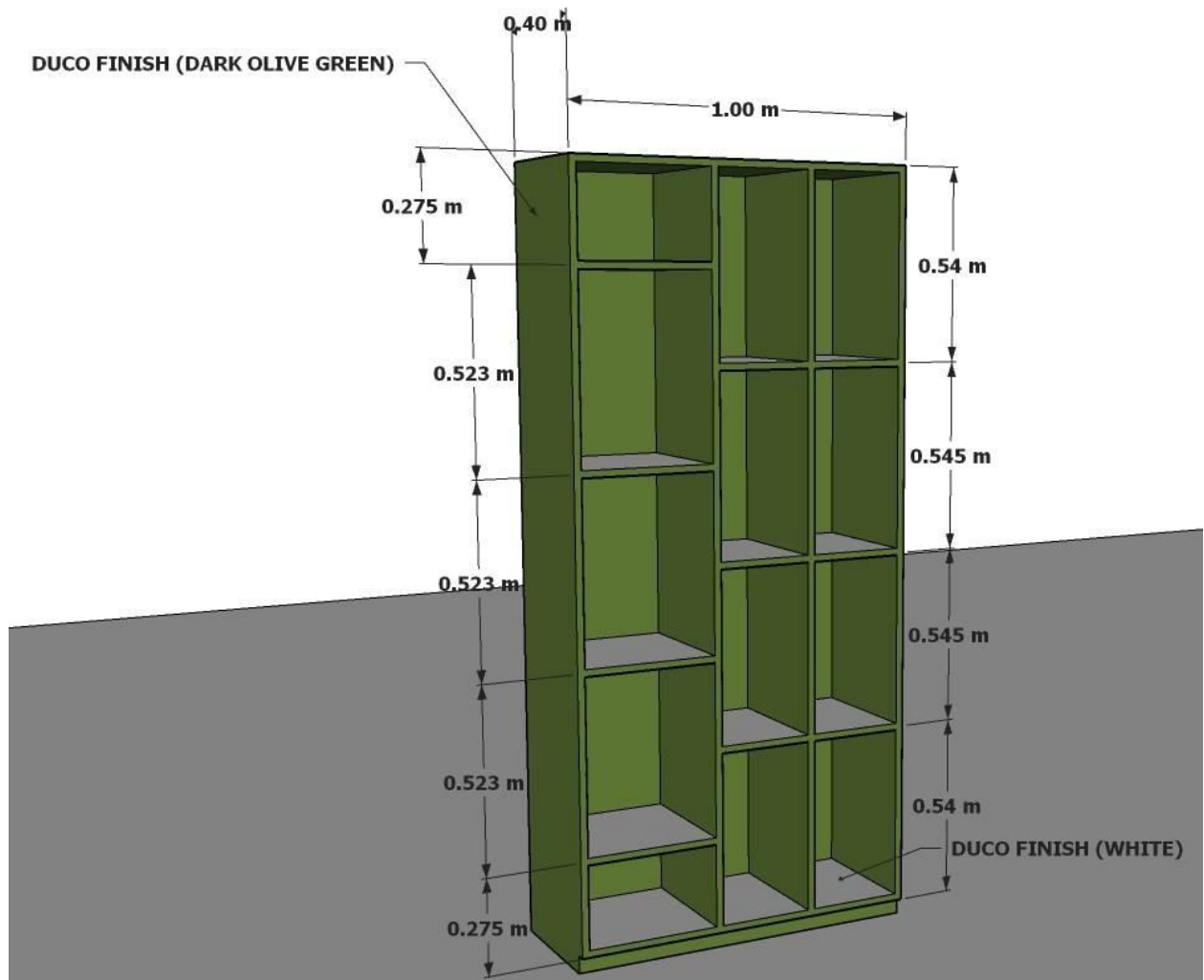

Figure 1.1.b

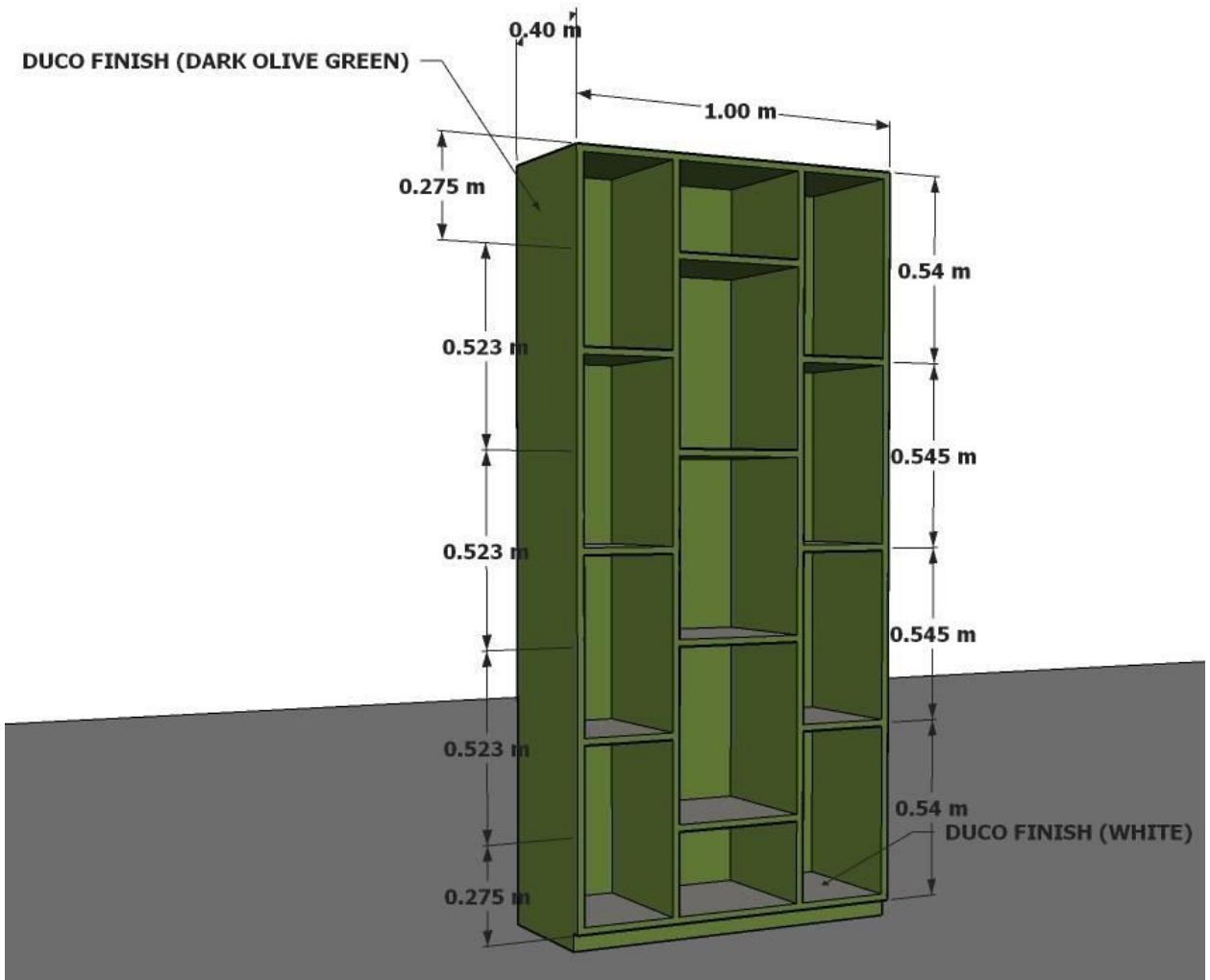

Figure 1.1.c

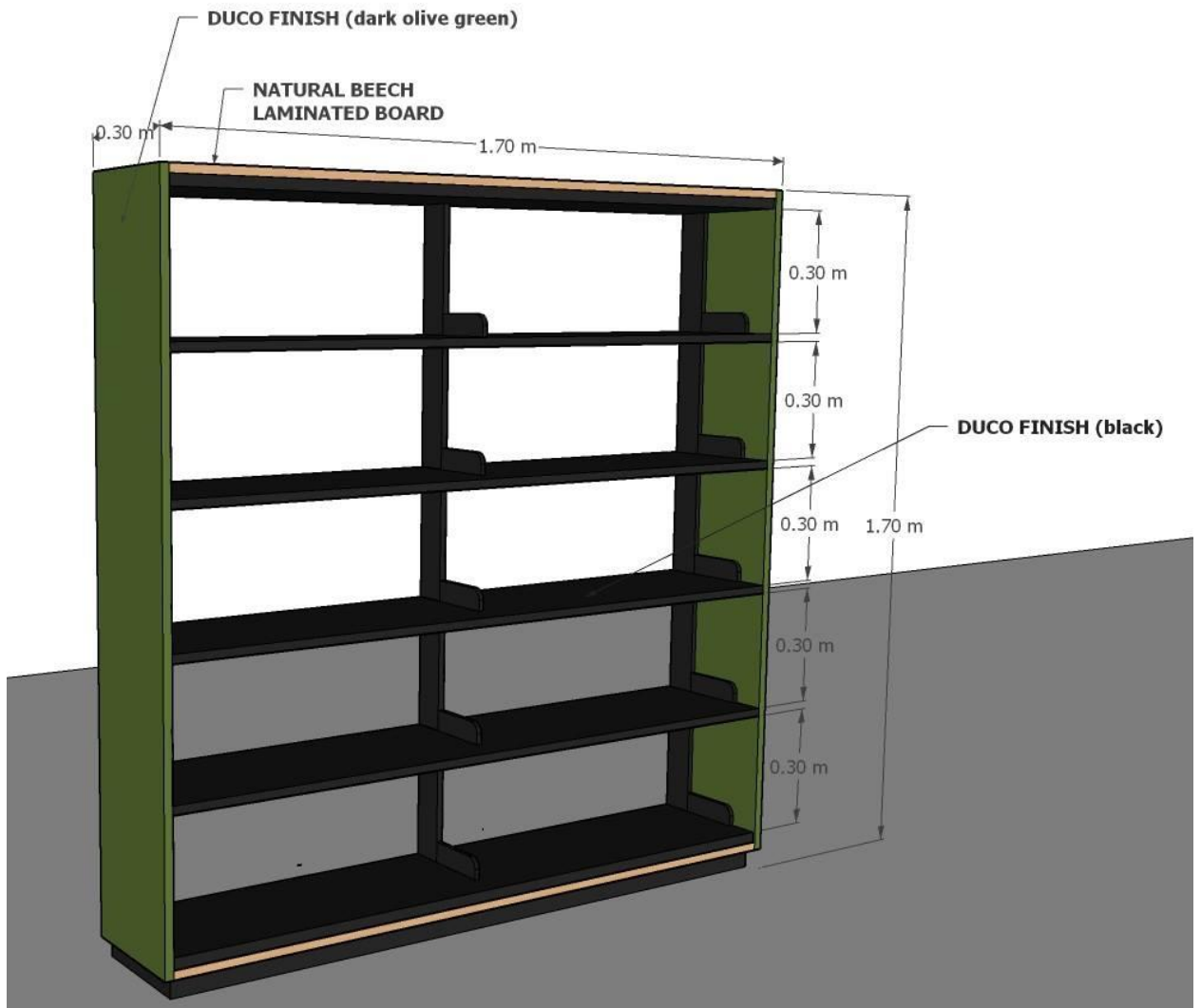

Figure 1.2

16 units

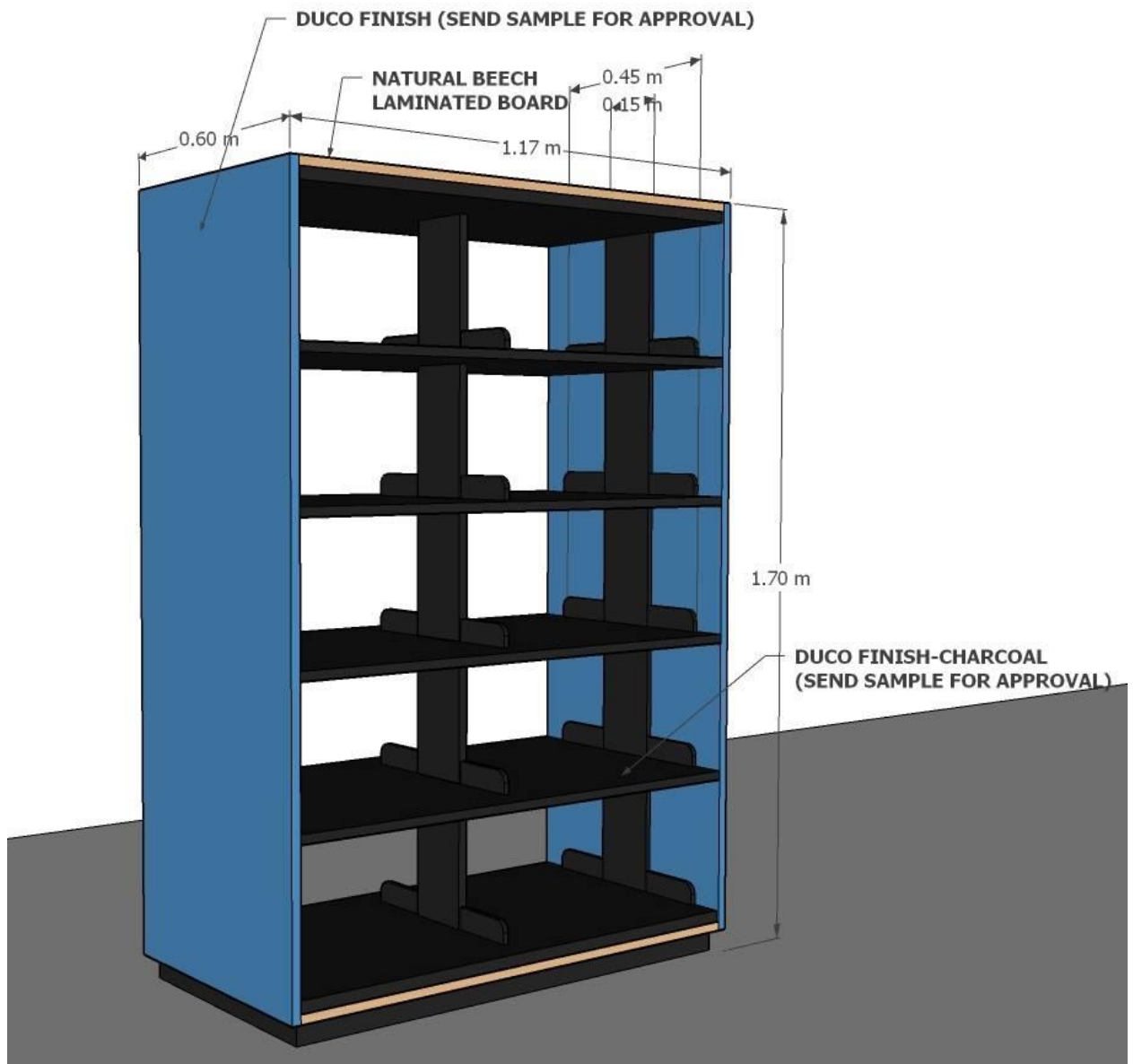

Figure 1.3

27 units – high

7 units - low

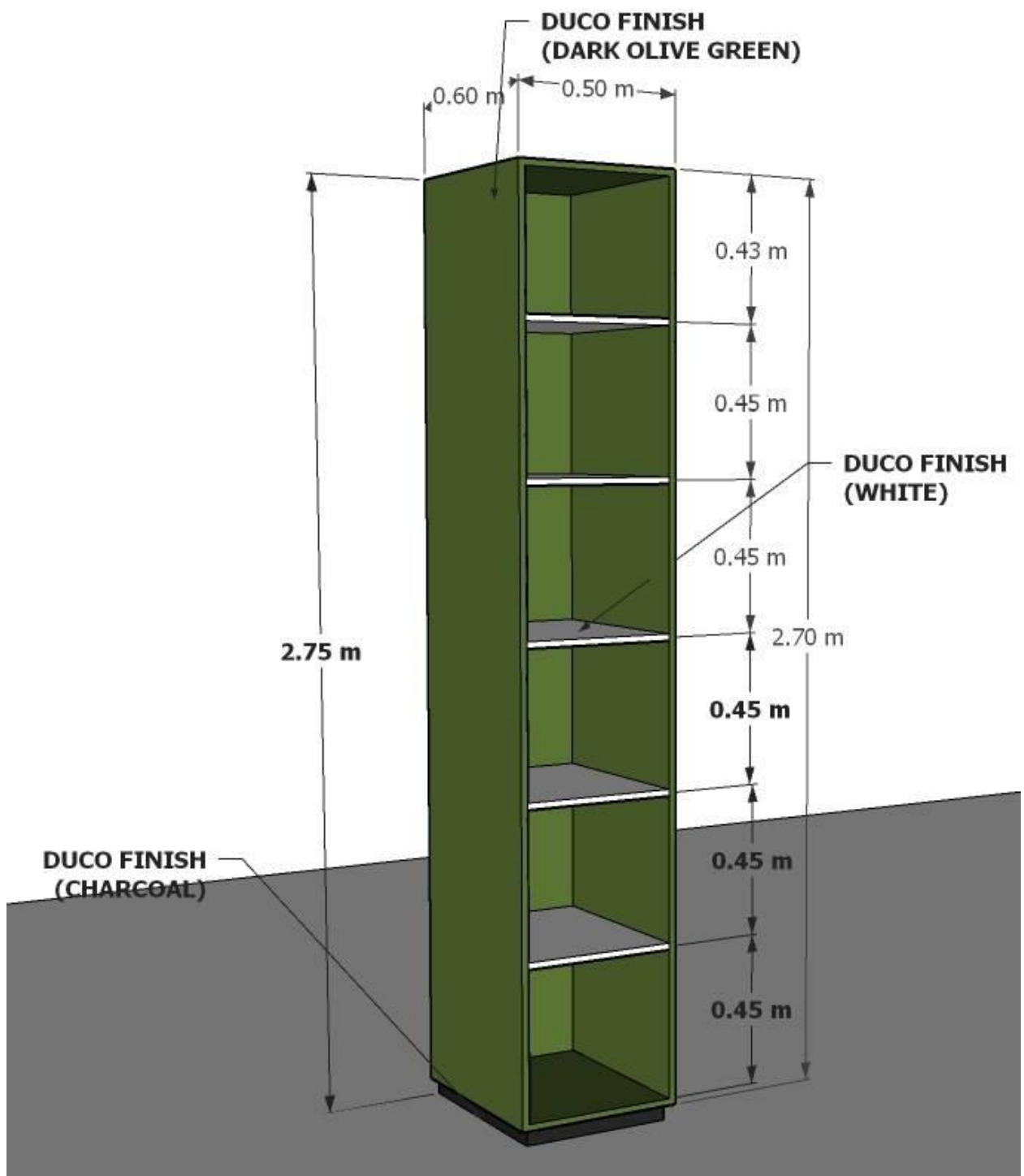

Figure 1.4

2 units

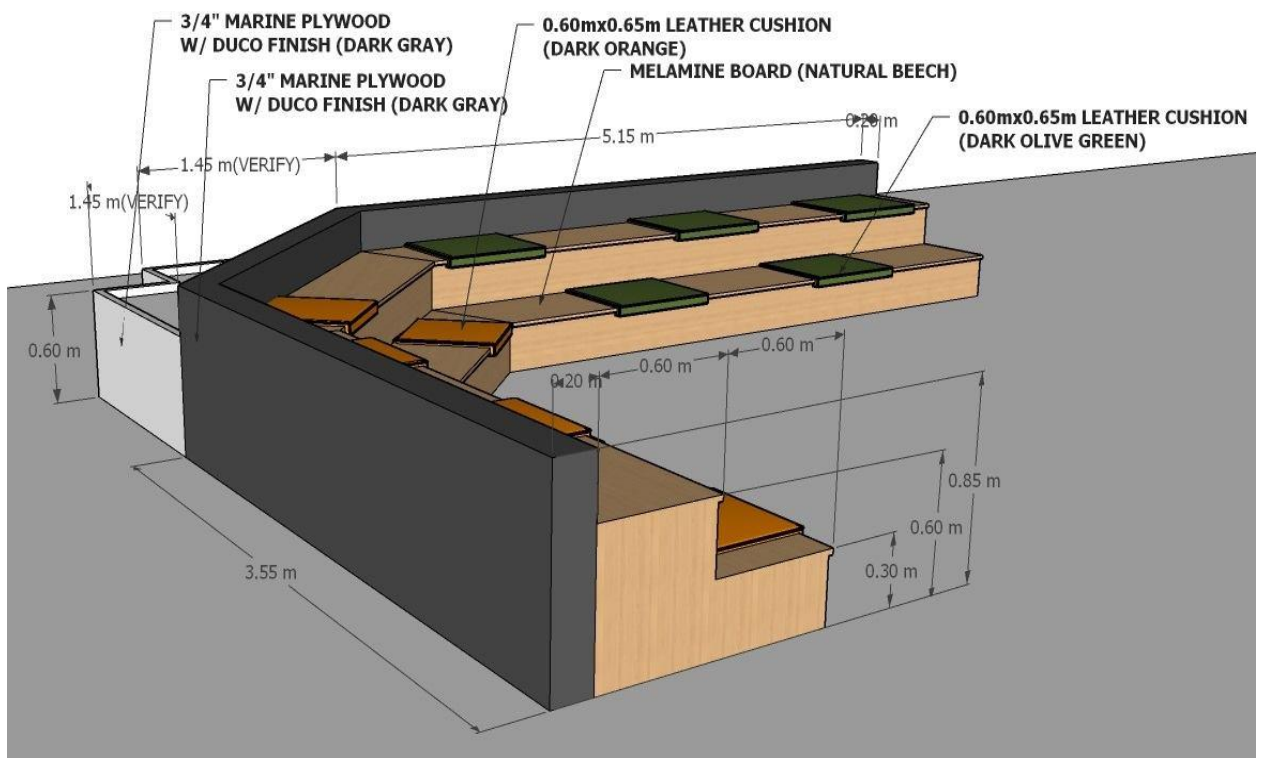

Figure 1.5

1 unit

1.) Built in magazine rack



2.) Built in periodicals rack

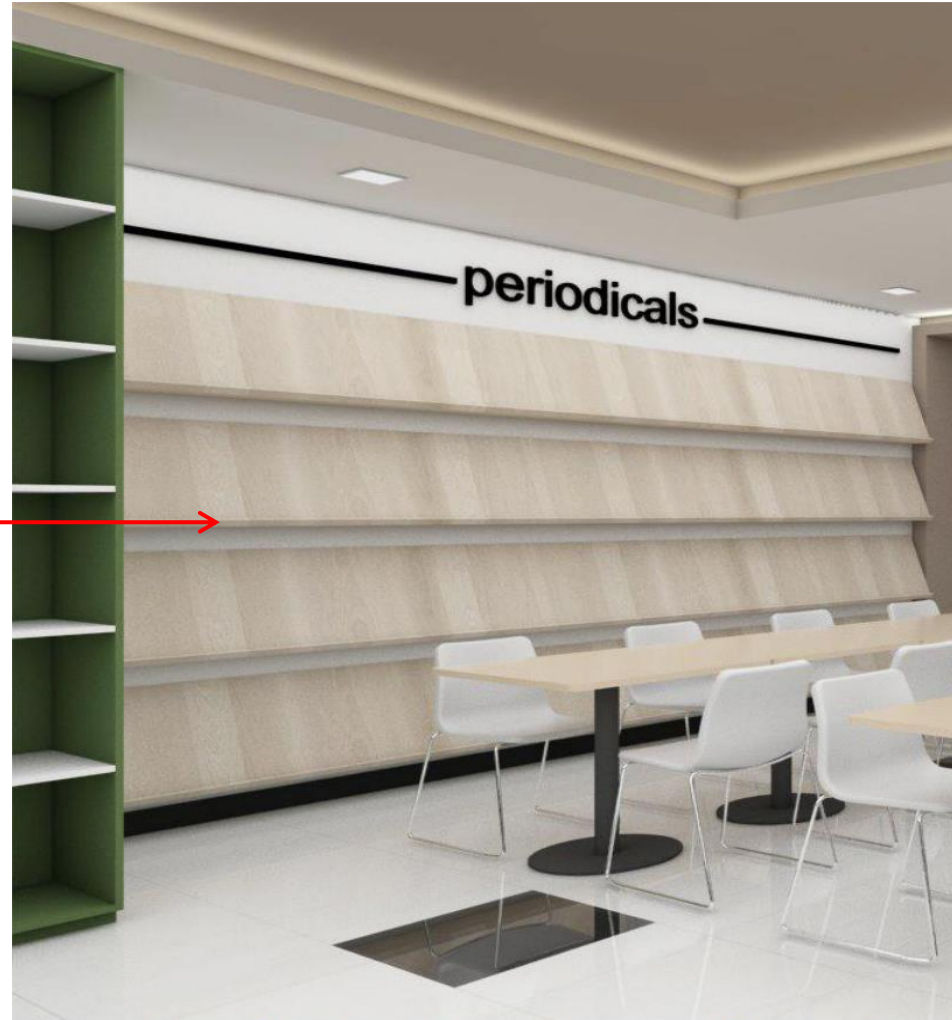

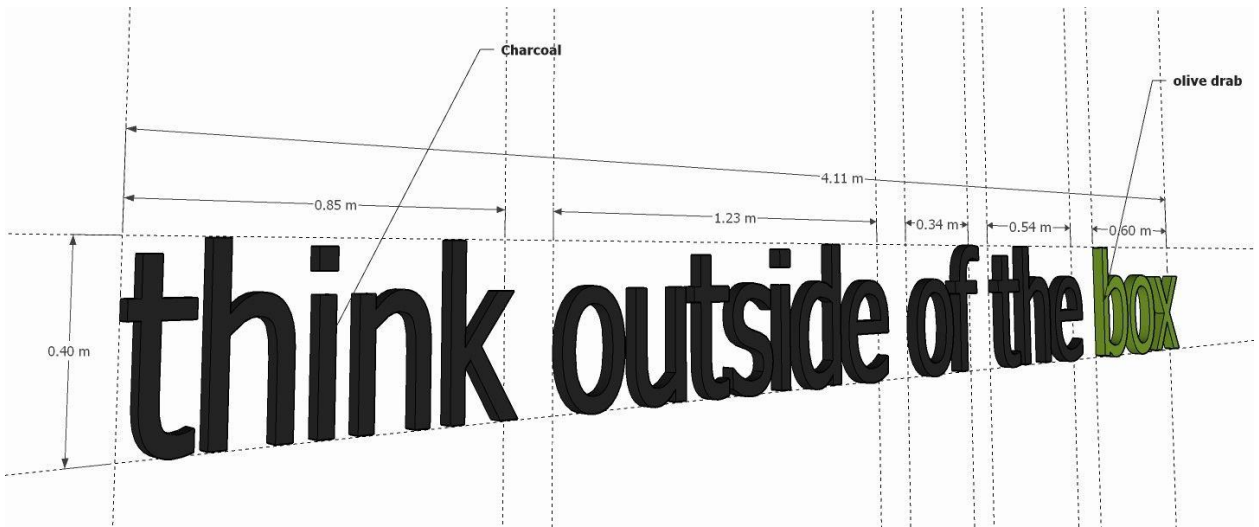

Figure 2.1

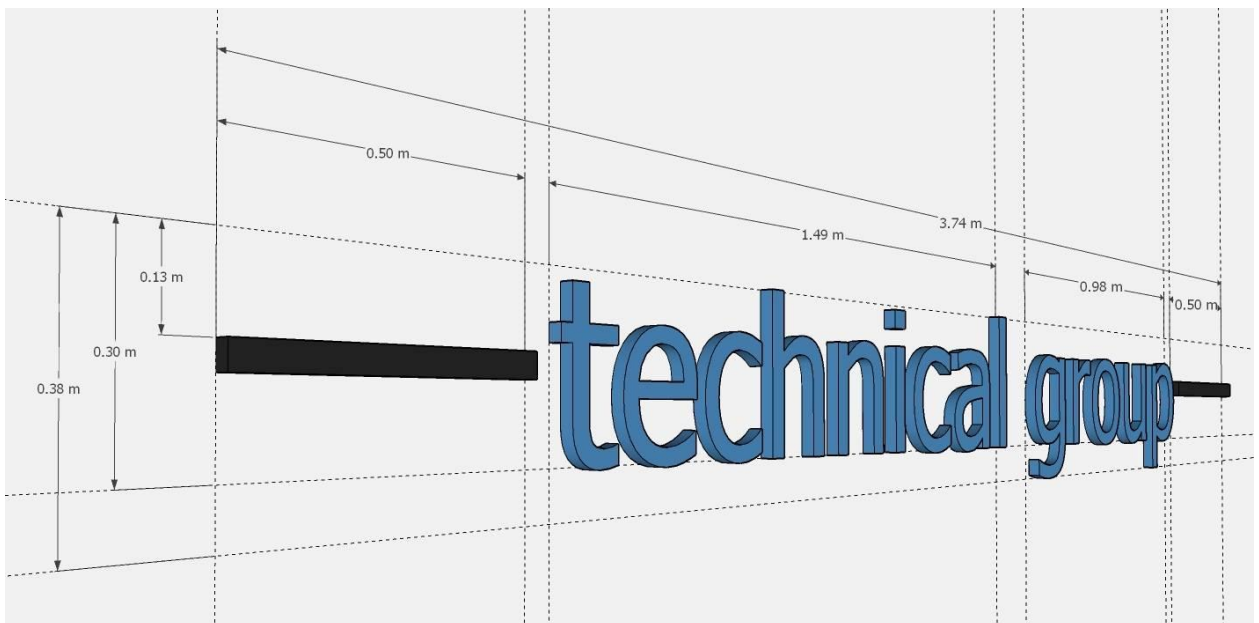

Figure 2.2

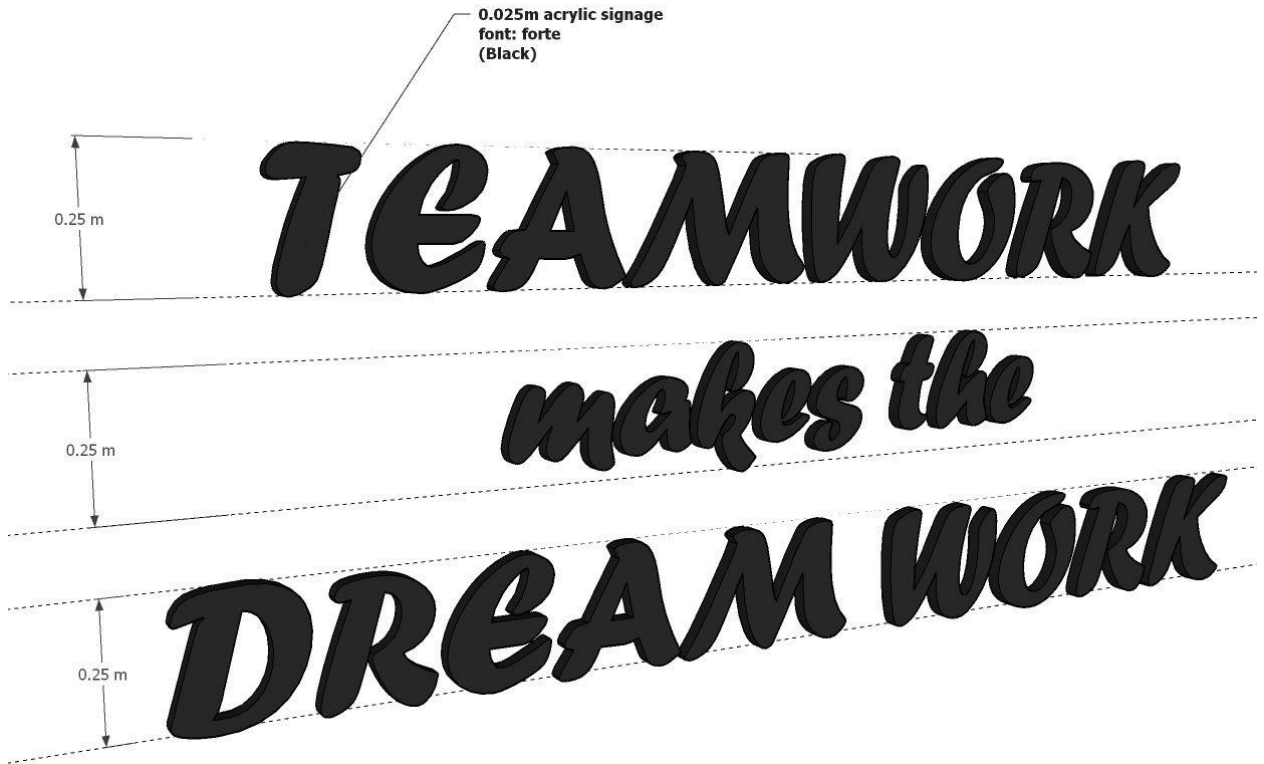

Figure 2.3

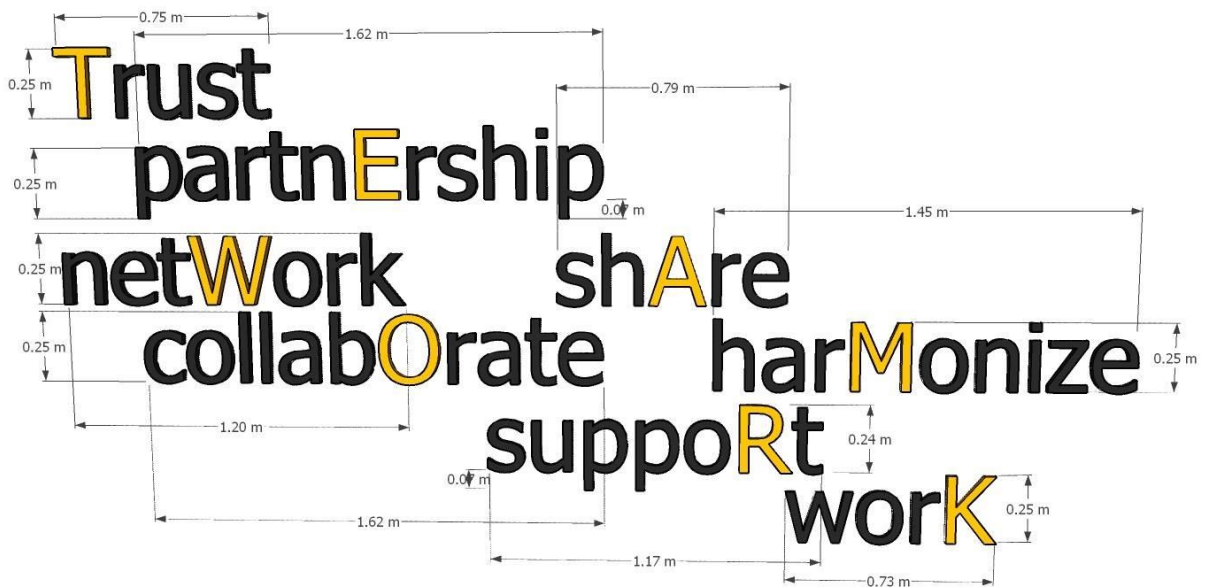

Figure 2.4

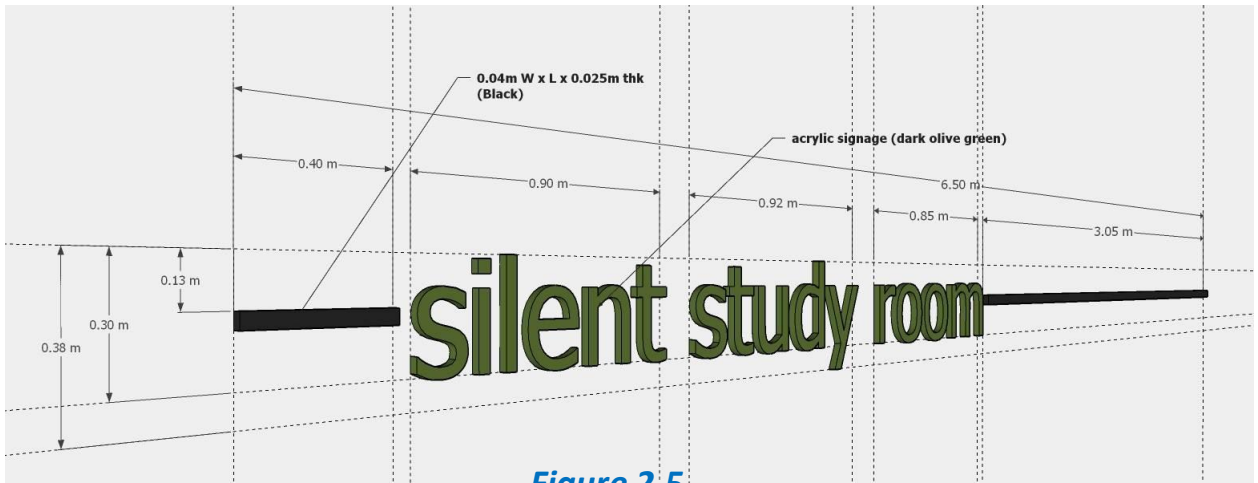

Figure 2.5

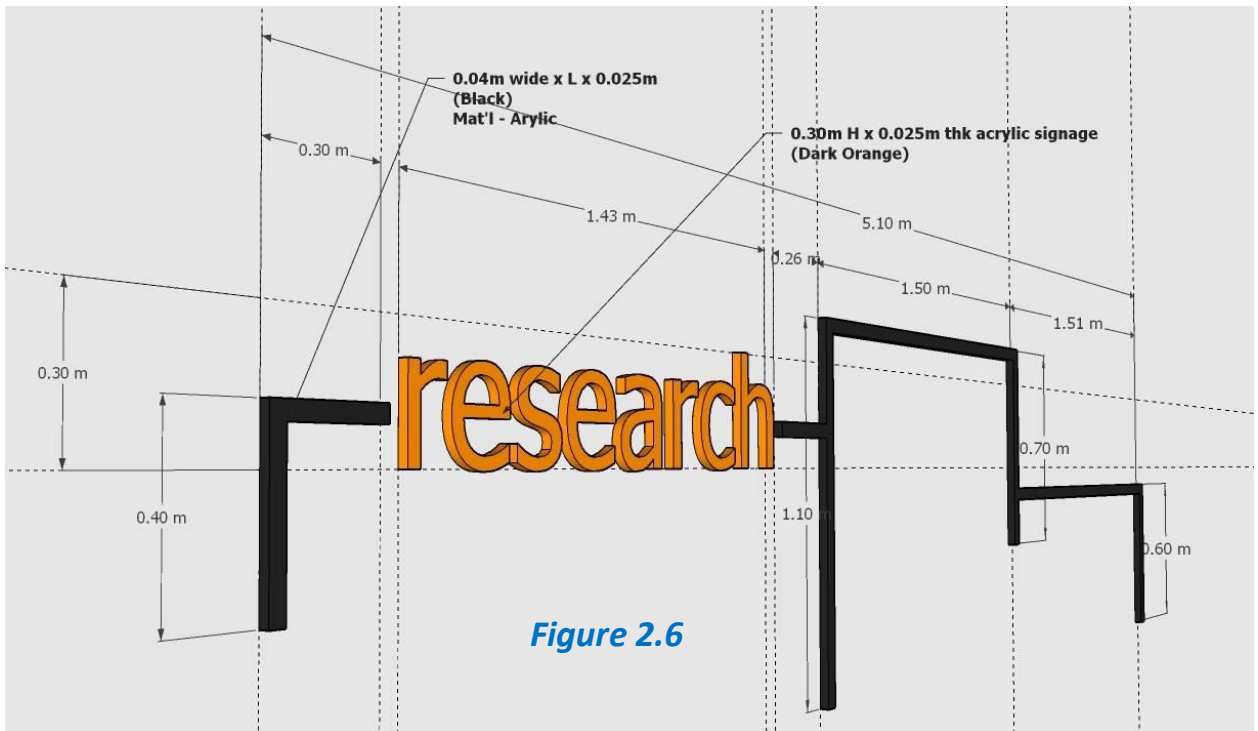

Figure 2.6

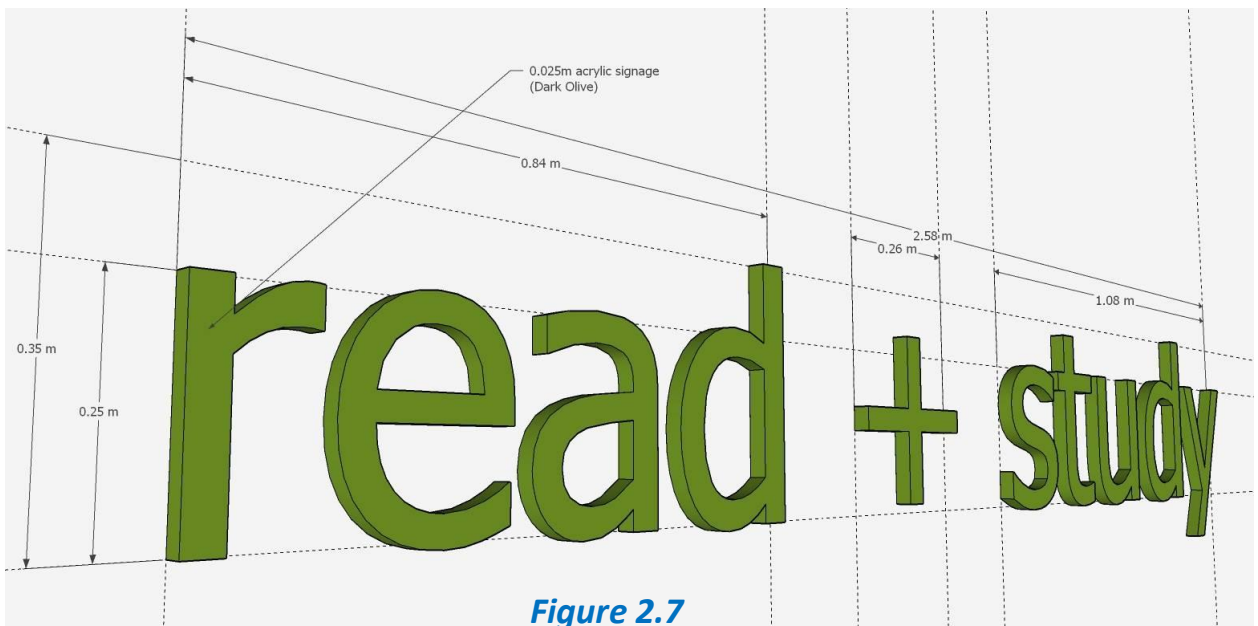

Figure 2.7

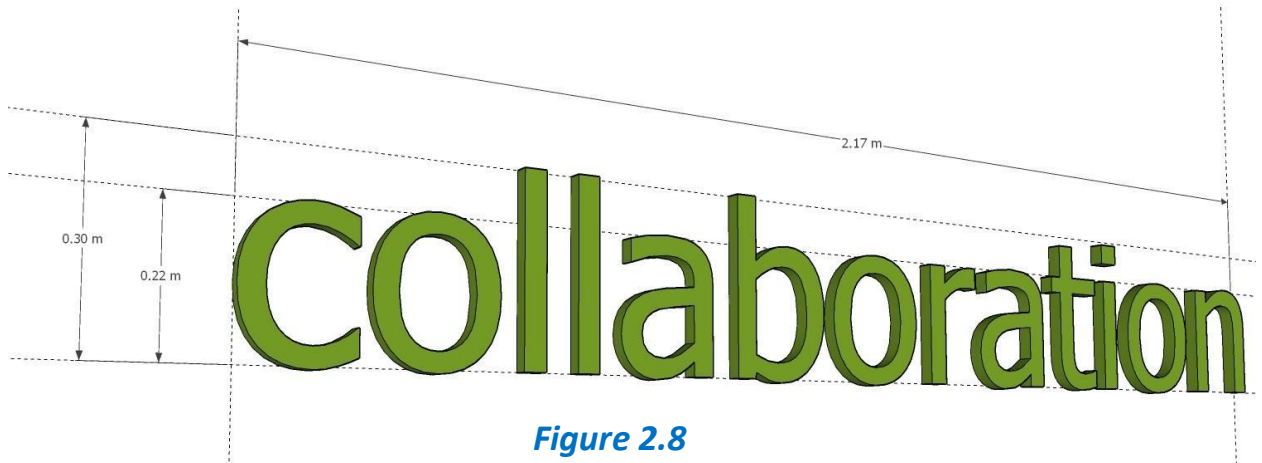

Figure 2.8

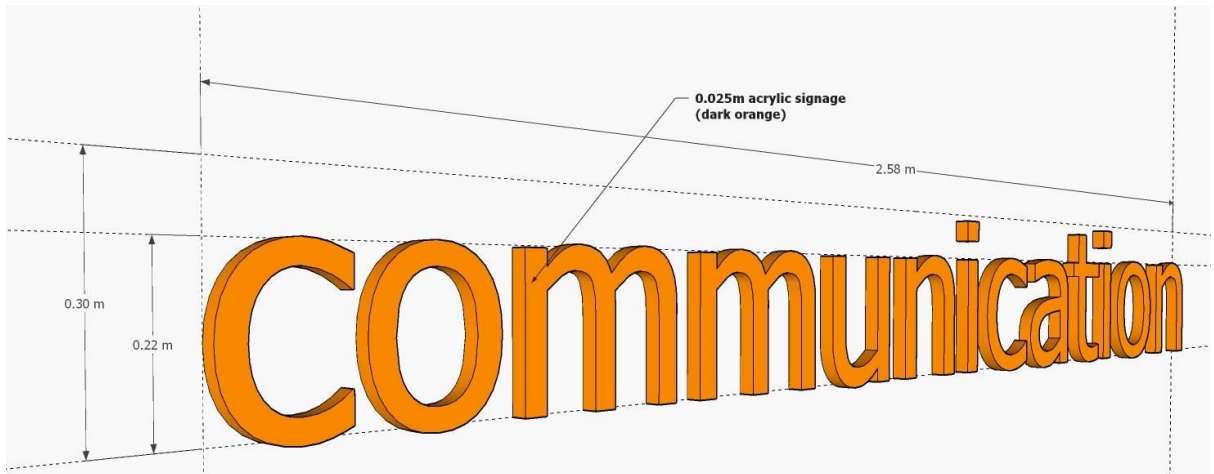

Figure 2.9

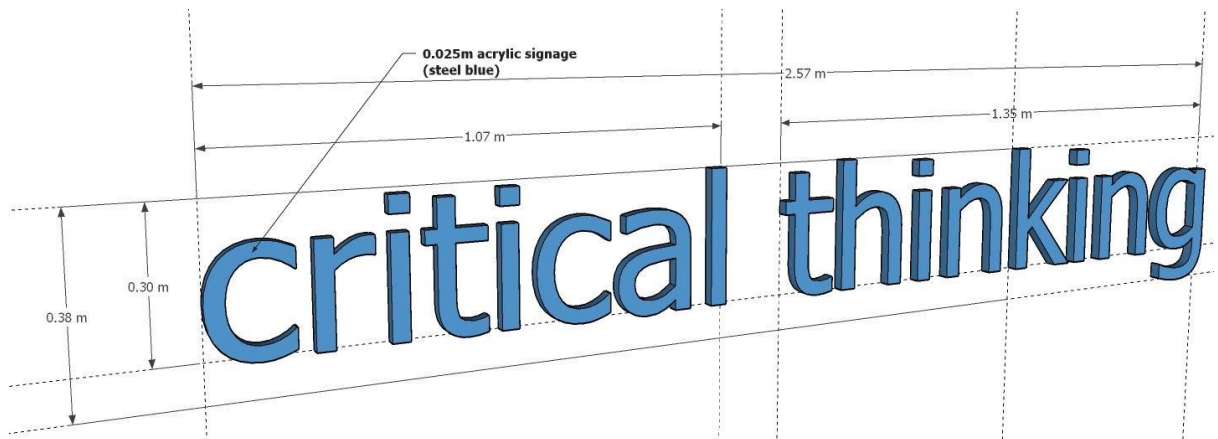
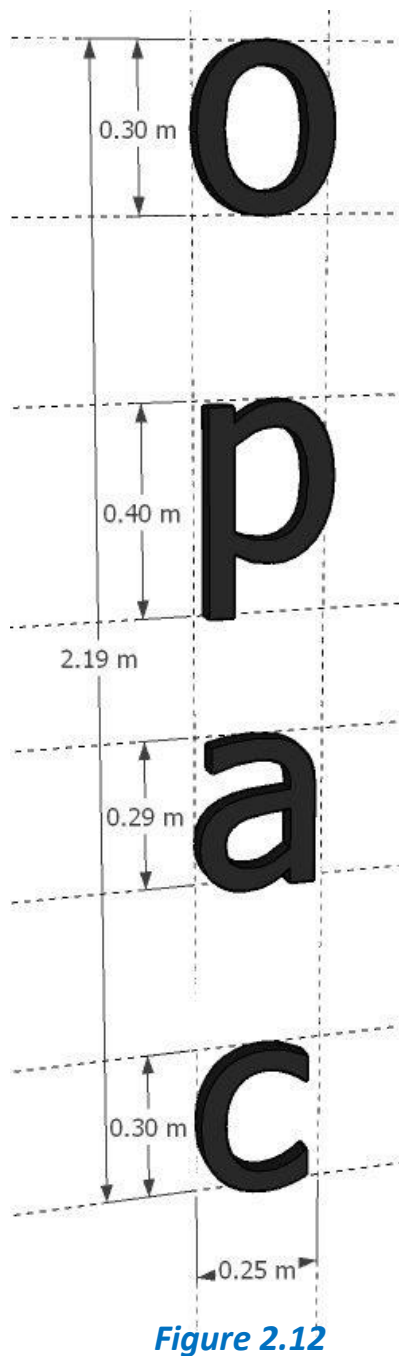
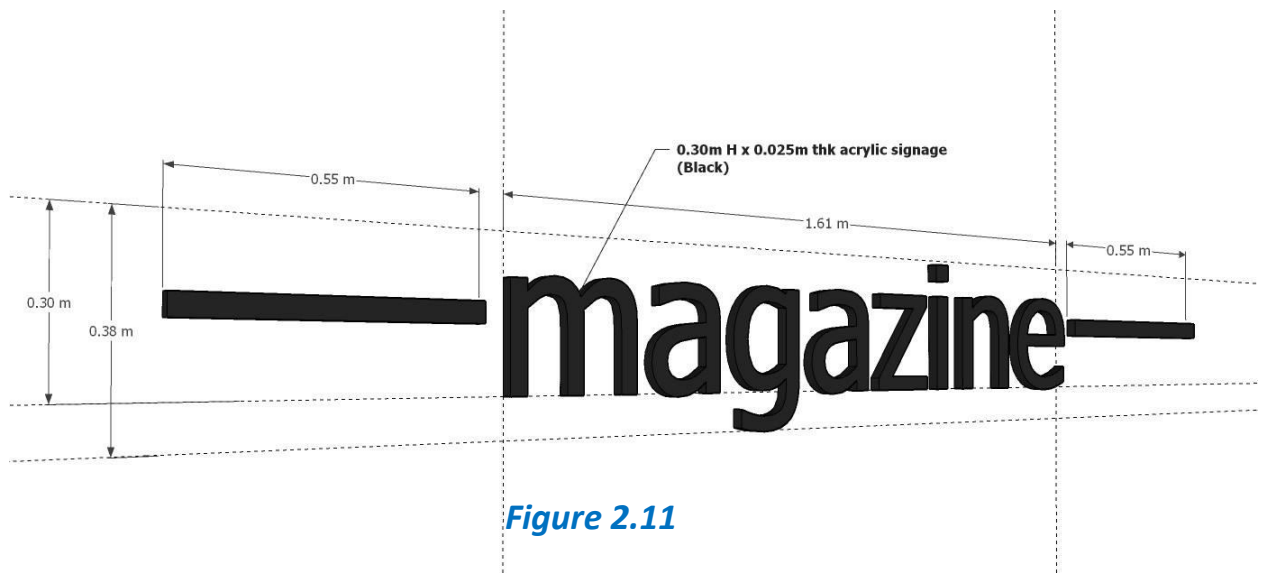

Figure 2.10



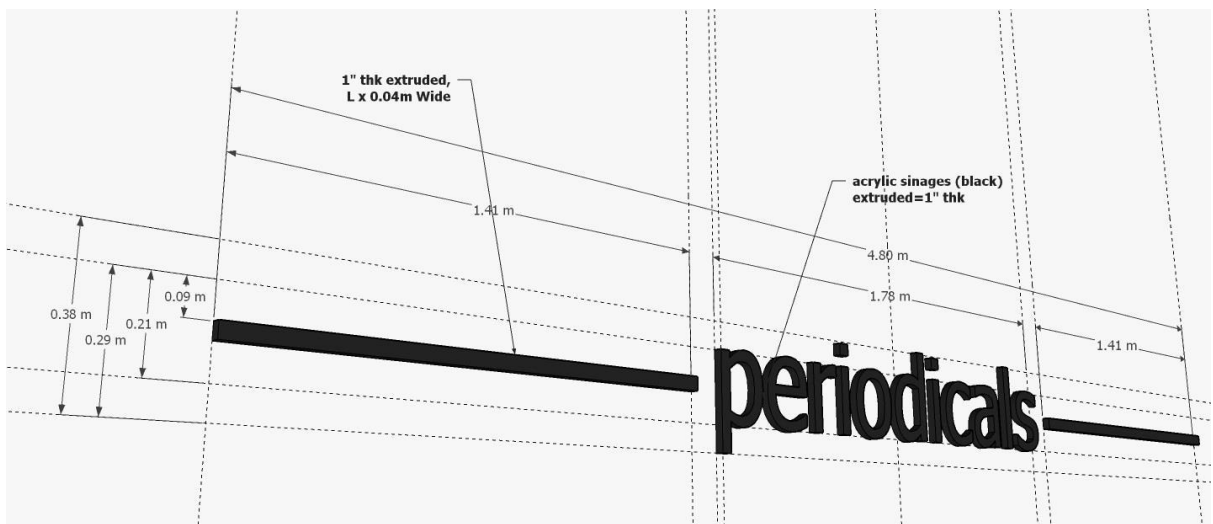

Figure 2.13